

A large, high-quality photograph of a modern, curved door handle in a light grey or white finish. The handle is shown from a side-on perspective, highlighting its smooth, ergonomic design. The background is a soft, out-of-focus gradient, making the handle the central focus of the image.

LEVER HANDLE
DOOR KNOB
ESCUTCHEON
WINDOW HANDLE
PULL HANDLE
PAD HANDLE
SLIDING DOOR PULL
DOOR CHAIN / BOLT
DOOR STOPPER
CABINET KNOB / PULL
ROBE HOOK
SHELF
TOILET PAPER HOLDER
TOWEL RAIL / RING

WEST architectural hardware **Catalog** vol 2





product
design
award

2008 9th

Agaho
Lever Handle 146

WEST architectural hardware : timeless serenity

If you visit ancient shrines in Japan, you will sometime notice that white sand symbolically formed as twin conical shape. This is known as "*morizuna*" and is believed to signify a landmark for the descent of God while the white sand signifies the purification of the place. In other words, "*morizuna*" expresses spirit of hospitality.

Wishing to inherit this spirit of hospitality, WEST has produce various range of products based on the conical shape. No matter how the era and the environment might change, we will continue to produce products that will be able to make people live in a harmony with our faith and confidence.

This is our philosophy of the WEST brand.



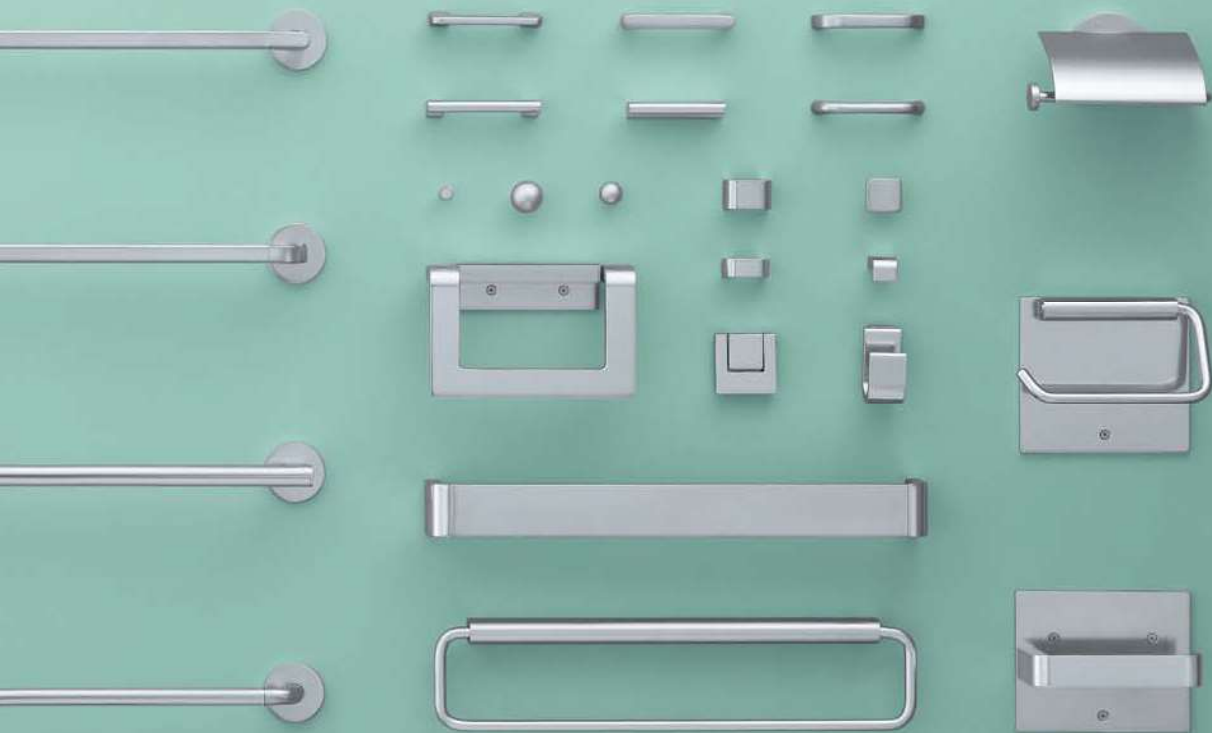
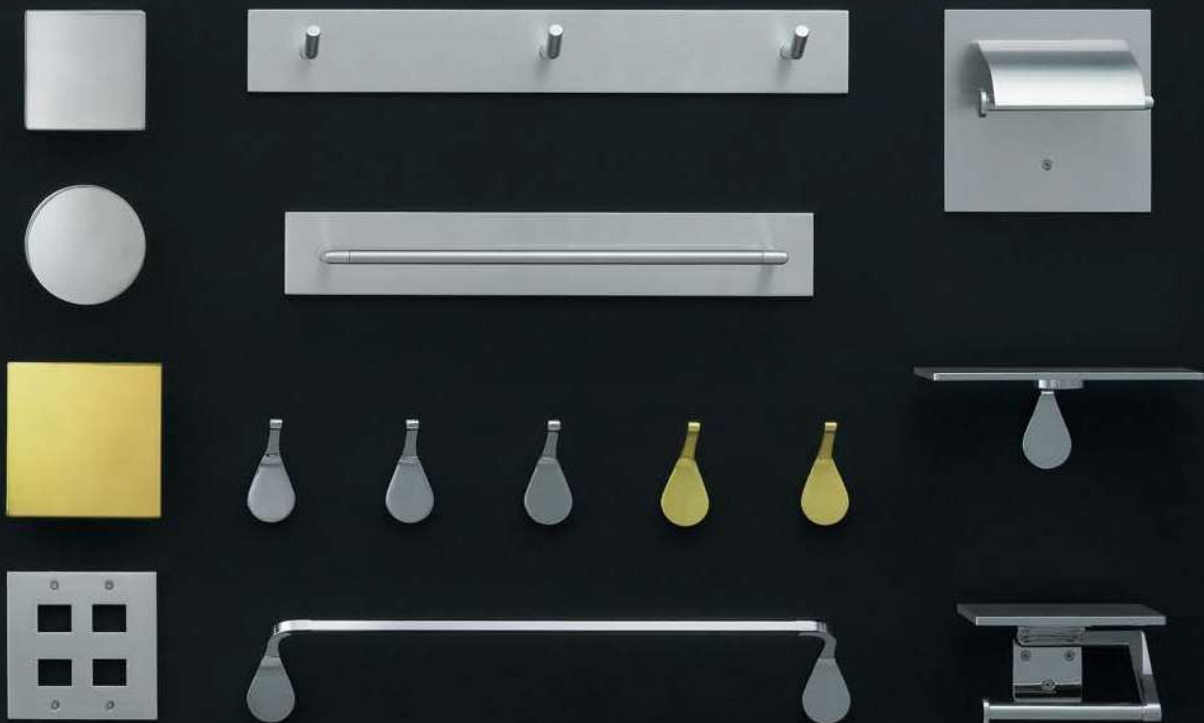

Agaho

Form generated through the exhaustive pursuit of function.

Simple but not minimal. Unique but harmonious. Functional, and yet beautiful.

The design of Agaho originates in the approach toward such conflicting themes. Bringing out the innate beauty of the material. Forms that describe soft lines even though they look sharp, and finish that feel warm to the touch. Everything has been created with a thorough pursuit of function in order to express the spirit of hospitality that is present in the history of the name of Agaho. This is WEST's flagship series.

Agaho S-line

An architectural hardware series created to be coordinated.

Having selected a lever handle, other hardware items such as cabinet knobs or towel rails may be coordinated in a unified design. Agaho S-line has been created using this concept, and some basic lever handles designs are available. The uniqueness of Agaho S-line is that the necessary items may be freely grouped as a simple design which inherits the original concept of Agaho. This series provides unusual degree of satisfaction in selecting architectural hardware.



F.O.B. Association

FOBA is a Kyoto-based practice founded in 1995 by Katsu Umebayashi (b.1963). Ranging from furniture to landscape projects, the majority of their work comprises inventive residential design. FOBA's style is sculptural in its forms and complex in its spaces, but always emerges from close reading of the local context and a deep understanding of Japan's cultural history.

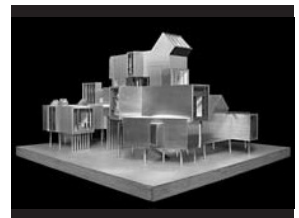

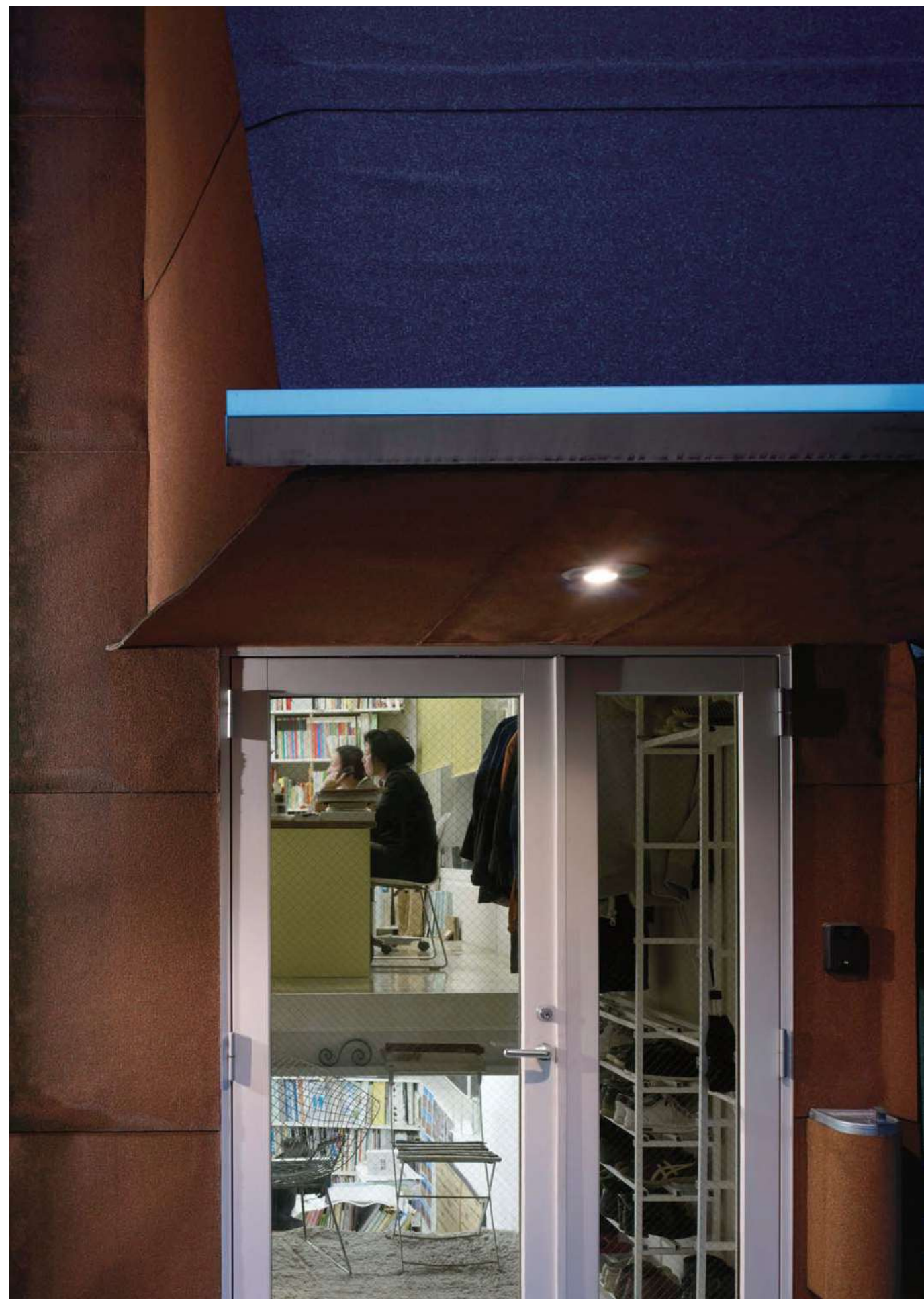

Atelier Bow-wow

Atelier Bow-Wow, the pair of Yoshiharu Tsukamoto (b.1965) and Momoyo Kaijima (b.1969), was founded in 1992. They began as a combined research and design practice, studying the modern vernacular of Tokyo, their home city. A series of humble yet innovative houses designs has led to larger projects and international fame, but the architects retain their original inquisitive and humorous approach.



House & Atelier Bow-Wow



Felix Claus

Born in the Netherlands, 1956. Graduated from the Delft Institute of Technology. Founding director of Claus en Kaan Architecten. Guest professor at the Swiss Federal Institute of Technology, Zurich. Grand Prix Rhénan d'Architecture (1997), Lensvelt De Architect Interior Prize (2005), Amsterdam Architecture Award (2009).



House in Jingumae



Jun Igarashi

Born in Hokkaido, 1970

Established Jun Igarashi Architects Inc., 1997
Instructor of Tohoku University, Nagoya Institute of
Technology, and Hokkaido Institute of Technology, 2011
Awards:

Architectural Institute of Japan Hokkaido Architectural
Encouragement Prize (1996), The 19th Yoshioka Prize
(2003), The Grand Prix of Osaka contemporary theater
festival's temporary playhouse competition (2004),

Biennale Internazionale di Architettura Barbara
Cappochin (2005), AR AWARDS EMERGING
ARCHITECTURE. The Grand Prix of American Wood
Design Awards 2006/ Best of Residential (2006), AR
AWARDS 2006 HONOURABLE MENTION (2006),
The Grand Prix of Japan Institute of Architecture
Hokkaido Branch Residential Division (2009),
The 21st JIA Rookie of the Year Award (2010),



Small Atelier

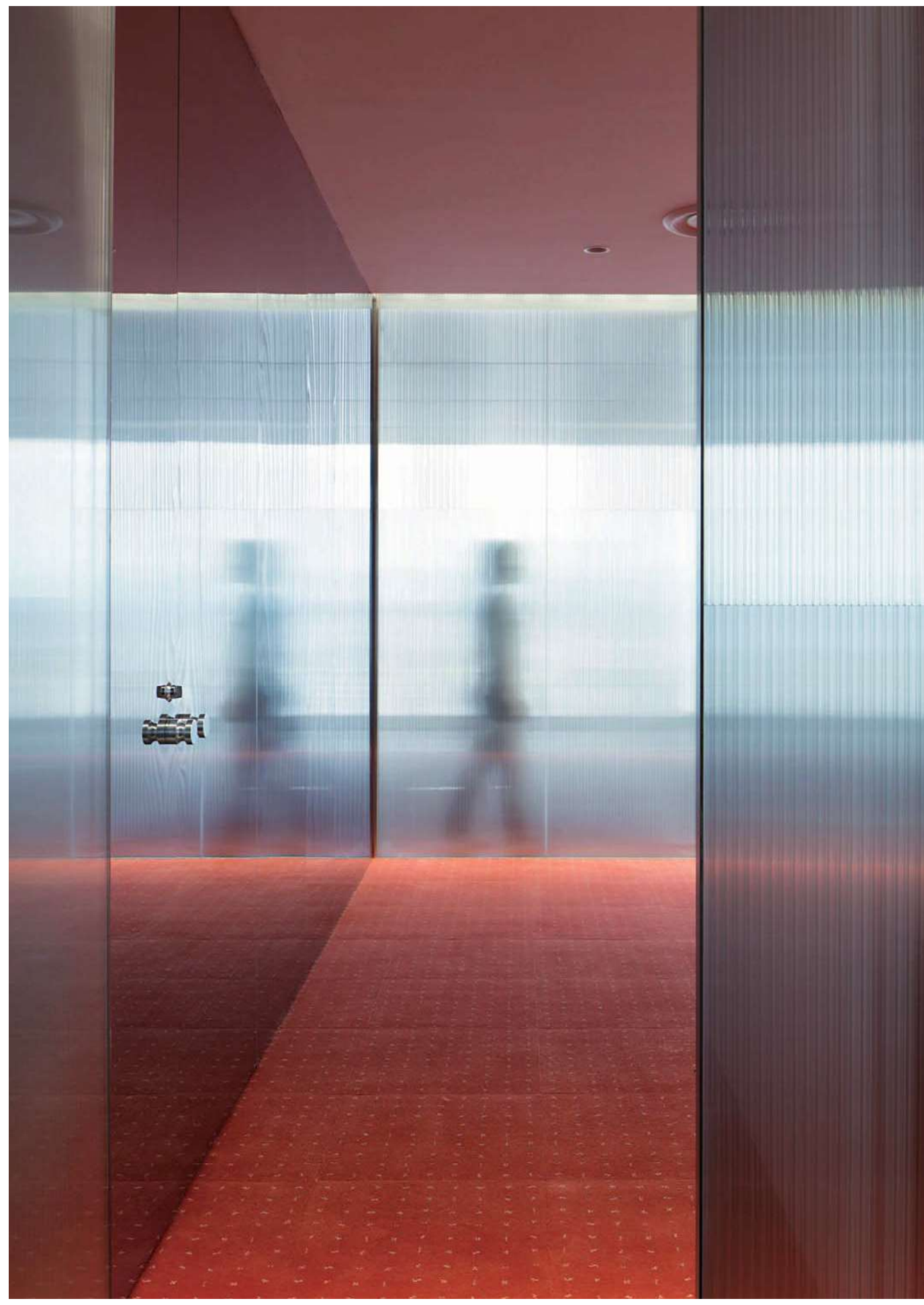

Shigeki Maeda

1974 Born in Osaka

1998 Graduated from Architecture and Building engineering, Osaka National University,

1998-2000 Master school in Tokyo National Univ. of fine arts and music,

2000-2009 Worked at Dominique Perrault Architecture in Paris

2009 Established Shigeki Maeda Architecture

2010 Established Geo-graphic Design Lab.

/ Lecturer in Osaka Institute of Technology

Works/Awards

1999 Finalist for the competition "Architecture for Humanity" Transitional House for KOSOVO refugee

2001 Honorable mention for SD review/ "synagogue at Rueil Malmaison"

2005 Laureate for the competition "New metro station of Nakanoshima new line" at Osaka, Japan

2010 Laureate for the international competition of the Bangladesh cyclone shelter.



REGO project Kansai Recruit



Table Of Contents

Lever Handle / Door Knob	Lever Handle	3
	Door Knob	
	Escutcheon	
	Window Handle	
Door Furniture	Pull Handle	29
	Pad Handle	
	Sliding Door Pull	
	Door Chain / Bolt	
	Door Stopper	
Cabinet Knob / Pull		55
Accessory	Robe Hook	61
	Shelf	
	Toilet Paper Holder	
	Towel Rail / Ring	
Agaho Brass	Lever Handle	76
	Escutcheon	
	Cabinet Knob	
	Robe Hook	
	Toilet Paper Holder	
	Towel Rail	
General Information	About Us	85
	Material and Finish	
	Technical Information	
	Order Guide	
	Article Number List	
	Terms and Conditions	

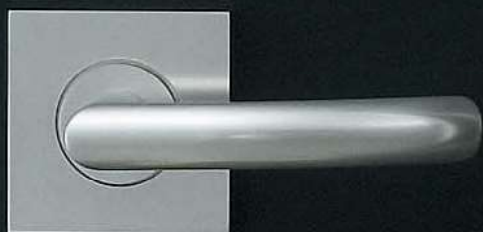
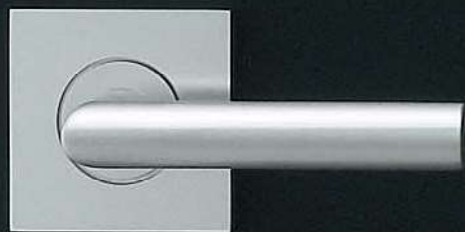

Lever Handle / Door Knob	Lever Handle	6
	Door Knob	20
	Escutcheon	24
	Window Handle	26

Lever Handle Agaho

146   P.6



148   P.7



149   P.8



185   P.9



Agaho S-line

209 P.10



210 P.11



211 P.12



212 P.13



214 P.14



215 P.15



217   P.16



219 P.17



238 P.18



Door Knob Agaho

154 P.20



192 P.22



193 P.23



194 P.21



Escutcheon

950 ● ● P. 24



957 ● ● P. 24



951 ● ● P. 24



952 ● ● P. 24



950S P. 25



957S P. 25



951S P. 25



952S P. 25



Window Handle

209W-O P. 26



209W-S P. 26



211W-O P. 26



211W-S P. 26



214W-O P. 26



214W-S P. 26



219W-O P. 27



219W-S P. 27



238W-O P. 27



238W-S P. 27



Agaho

Lever Handle

146

Material: Aluminium

Finish:

● Clear Anodized

● Matte Black

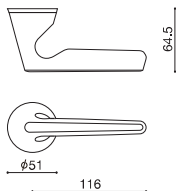

146-A
Lever Handle



146-B
Lever Handle + 950 Escutcheon

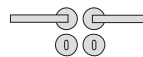

146-C
Lever Handle + 957 Escutcheon

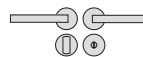

146-D
Lever Handle + 951 Bathroom Set

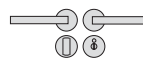

146-E
Lever Handle + 952 Bathroom Set

Agaho

Lever Handle

148

Material: Aluminium

Finish:

● Clear Anodized

● Matte Black

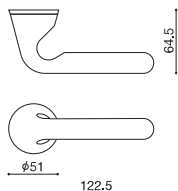

148-A

Lever Handle



148-B

Lever Handle + 950 Escutcheon



148-C

Lever Handle + 957 Escutcheon



148-D

Lever Handle + 951 Bathroom Set



148-E

Lever Handle + 952 Bathroom Set

Agaho

Lever Handle

149

Material: Aluminium

Finish:

● Clear Anodized

● Matte Black

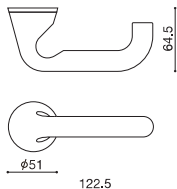

149-A

Lever Handle



149-B

Lever Handle + 950 Escutcheon

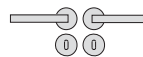

149-C

Lever Handle + 957 Escutcheon

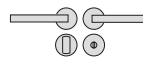

149-D

Lever Handle + 951 Bathroom Set



149-E

Lever Handle + 952 Bathroom Set

Agaho

Lever Handle

185

Material: Aluminium

Finish:

- Clear Anodized
- Matte Black

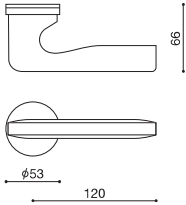

185-A
Lever Handle



185-B
Lever Handle + 950 Escutcheon



185-C
Lever Handle + 957 Escutcheon



185-D
Lever Handle + 951 Bathroom Set



185-E
Lever Handle + 952 Bathroom Set

Agaho S-line



Lever Handle

209

Material: Aluminium

Finish:

● Clear Anodized

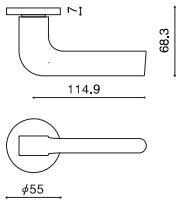

209-A
Lever Handle

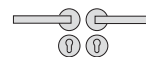

209-B
Lever Handle + 950 Escutcheon



209-C
Lever Handle + 957 Escutcheon



209-D
Lever Handle + 951 Bathroom Set



209-E
Lever Handle + 952 Bathroom Set

Agaho S-line



Lever Handle

210

Material: Aluminium

Finish:

● Clear Anodized

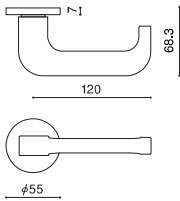

210-A
Lever Handle

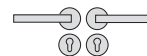

210-B
Lever Handle + 950 Escutcheon



210-C
Lever Handle + 957 Escutcheon



210-D
Lever Handle + 951 Bathroom Set



210-E
Lever Handle + 952 Bathroom Set

Lever Handle

211

Material: Aluminium

Finish:

● Clear Anodized

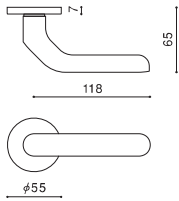

211-A
Lever Handle

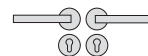

211-B
Lever Handle + 950 Escutcheon



211-C
Lever Handle + 957 Escutcheon



211-D
Lever Handle + 951 Bathroom Set

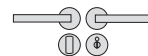

211-E
Lever Handle + 952 Bathroom Set

Lever Handle

212

Material: Aluminium

Finish:

● Clear Anodized

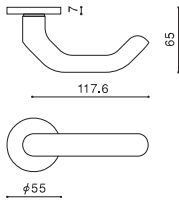

212-A
Lever Handle

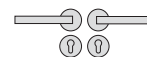

212-B
Lever Handle + 950 Escutcheon

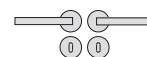

212-C
Lever Handle + 957 Escutcheon



212-D
Lever Handle + 951 Bathroom Set



212-E
Lever Handle + 952 Bathroom Set

Lever Handle

214

Material: Aluminium

Finish:

● Clear Anodized

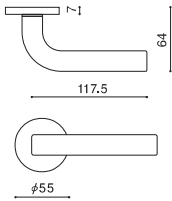

214-A
Lever Handle

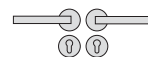

214-B
Lever Handle + 950 Escutcheon

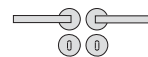

214-C
Lever Handle + 957 Escutcheon

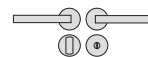

214-D
Lever Handle + 951 Bathroom Set

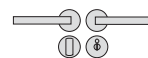

214-E
Lever Handle + 952 Bathroom Set

Lever Handle

215

Material: Aluminium

Finish:

● Clear Anodized

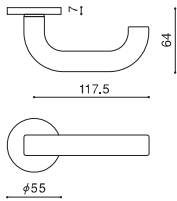

215-A
Lever Handle

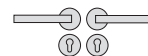

215-B
Lever Handle + 950 Escutcheon



215-C
Lever Handle + 957 Escutcheon



215-D
Lever Handle + 951 Bathroom Set



215-E
Lever Handle + 952 Bathroom Set

Lever Handle

217

Material: Aluminium

Finish:

● Clear Anodized

● Matte Black

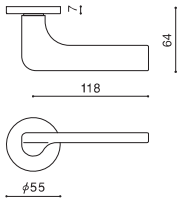

217-A R/L
Lever Handle



217-B R/L
Lever Handle + 950 Escutcheon



217-C R/L
Lever Handle + 957 Escutcheon



217-D R/L
Lever Handle + 951 Bathroom Set



217-E R/L
Lever Handle + 952 Bathroom Set

Lever Handle

219

Material: Aluminium

Finish:

● Clear Anodized

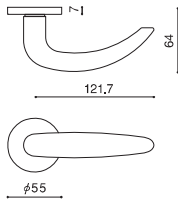

219-A
Lever Handle



219-B
Lever Handle + 950 Escutcheon



219-C
Lever Handle + 957 Escutcheon



219-D
Lever Handle + 951 Bathroom Set



219-E
Lever Handle + 952 Bathroom Set

AgahoS-line



Lever Handle

238

Material: Aluminium

Finish:

● Clear Anodized

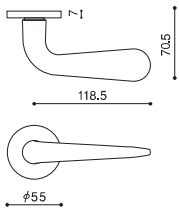

238-A
Lever Handle



238-B
Lever Handle + 950 Escutcheon



238-C
Lever Handle + 957 Escutcheon



238-D
Lever Handle + 951 Bathroom Set



238-E
Lever Handle + 952 Bathroom Set



Agaho

Door Knob

154

Material: Aluminium

Finish:

● Clear Anodized



∅50



55



154-A

Door Knob (Pair / Operable)



154-AF

Door Knob (Pair / Fixed)
For Glass Door 8-15 mm thick.



154-HF

Door Knob (One side / Fixed)

Agaho

Door Knob

194

Material: Aluminium

Finish:

● Clear Anodized

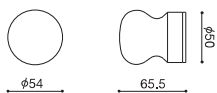

 **194-A**
Door Knob (Pair / Operable)

 **194-AF**
Door Knob (Pair / Fixed)
For Glass Door 8-15 mm thick.

 **194-HF**
Door Knob (One side / Fixed)

Agaho

Door Knob

192

Material: Aluminium

Finish:

● Clear Anodized

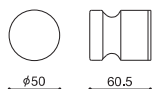

 **192-A**
Door Knob (Pair / Operable)

 **192-AF**
Door Knob (Pair / Fixed)
For Glass Door 8-15 mm thick.

 **192-HF**
Door Knob (One side / Fixed)

Agaho

Door Knob

193

Material: Aluminium

Finish:

● Clear Anodized

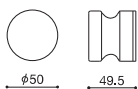

 **193-A**
Door Knob (Pair / Operable)

 **193-AF**
Door Knob (Pair / Fixed)
For Glass Door 8-15 mm thick.

 **193-HF**
Door Knob (One side / Fixed)

Escutcheon

950

Euro Profile Cylinder Escutcheon

Material: Aluminium

Finish:

● Clear Anodized

● Matte Black

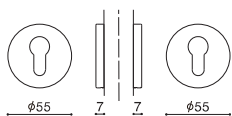

957

Standard Profile Escutcheon

Material: Aluminium

Finish:

● Clear Anodized

● Matte Black

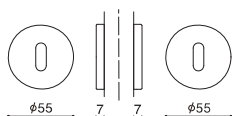

951

Bathroom Set

Material: Aluminium

Finish:

● Clear Anodized

● Matte Black

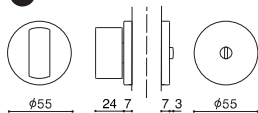

952

Bathroom Set with Indicator

Material: Aluminium

Finish:

● Clear Anodized

● Matte Black

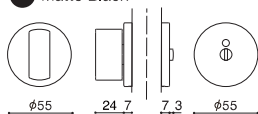

Escutcheon

950S

Euro Profile Cylinder Escutcheon (Square)

Material: Aluminium

Finish:

● Clear Anodized

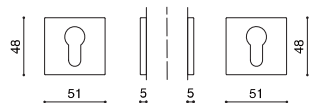

957S

Standard Profile Escutcheon (Square)

Material: Aluminium

Finish:

● Clear Anodized

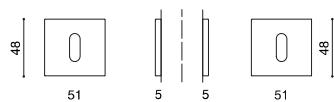

951S

Bathroom Set (Square)

Material: Aluminium

Finish:

● Clear Anodized

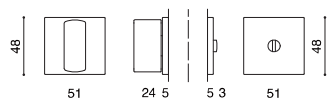

952S

Bathroom Set with Indicator (Square)

Material: Aluminium

Finish:

● Clear Anodized

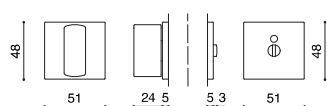

Window Handle

209W-O

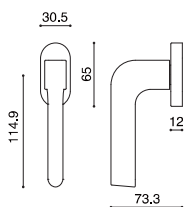

209W-S

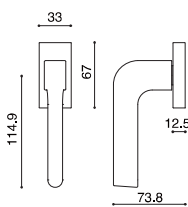

211W-O

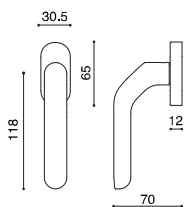

211W-S

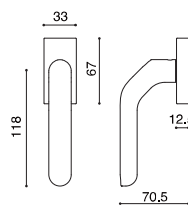

214W-O

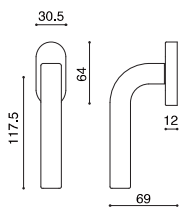

214W-S

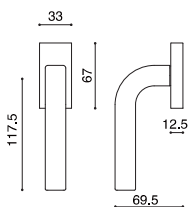

Window Handle

219W-O

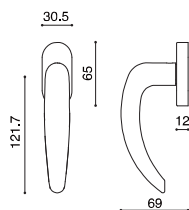

219W-S

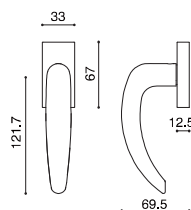

238W-O

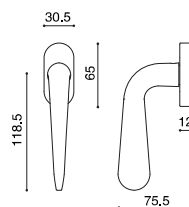

238W-S

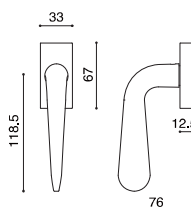



Door Furniture	Pull Handle	32
	Pad Handle	34
	Sliding Door Pull	36
	Door Chain / Bolt	46
	Door Stopper	47

**Pull Handle
Agaho**

9401 P. 32



9402 P. 32



Agaho

9002 P. 33

9003 P. 33

9004 P. 33



**Pad Handle
Agaho**

9030 P. 35



9040 P. 34



9050 P. 35



**Door Stopper
Agaho**

11D P. 47



12D P. 48



13D P. 48



Agaho S-line

20D P. 49



21D P. 49



23D P. 50



24D P. 50



25D P. 51



26D P. 52



Sliding Door Pull Agaho

400 P. 44



431 P. 38



431L P. 38



435 P. 36



435L P. 37



432 P. 39



432L P. 39



416 P. 42



426 P. 40



427 P. 40



427L P. 41



428 P. 40



429 P. 40



Agaho S-line

425 P. 43



Pocket Door Pull Agaho

10B P. 45



Door Chain / Bolt Agaho

10K P. 46



10A P. 46



Agaho

Pull Handle

9401

Material: Aluminium

Finish:

● Clear Anodized

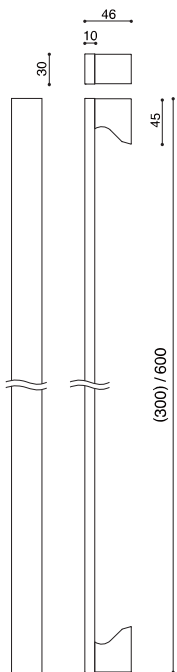

Pull Handle

9402

Material: Aluminium

Finish:

● Clear Anodized

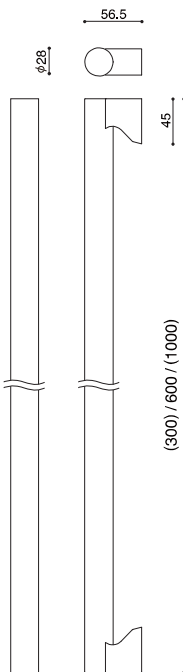

Agaho

Pull Handle

9002/9003/9004

Material: Aluminium

Finish:

● Clear Anodized

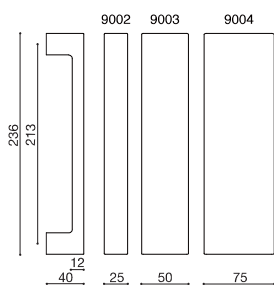

Agaho

Pad Handle

9040

Material: Aluminium

Finish:

● Clear Anodized

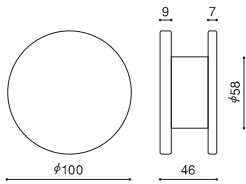

Agaho

Pad Handle

9030

Material: Aluminium

Finish:

● Clear Anodized

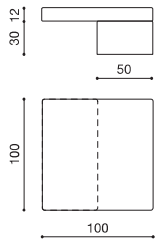

9050

Material: Aluminium

Finish:

● Clear Anodized

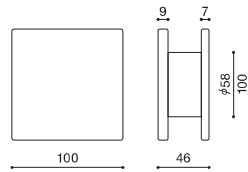

Agaho

Sliding Door Pull

435

Material: Aluminium

Finish:

● Clear Anodized

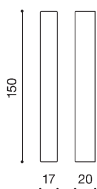

Agaho

Sliding Door Lock Set

435L

Material: Aluminium

Finish:

● Clear Anodized

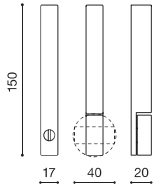

Agaho

Sliding Door Pull

431

Material: Aluminium

Finish:

● Clear Anodized

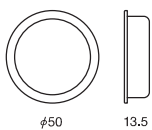

One side

Sliding Door Lock Set

431L

Material: Aluminium

Finish:

● Clear Anodized

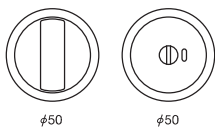

Agaho

Sliding Door Pull

432

Material: Aluminium

Finish:

● Clear Anodized

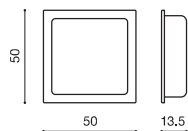

One side

Sliding Door Lock Set

432L

Material: Aluminium

Finish:

● Clear Anodized

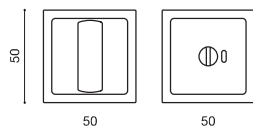

Agaho

Sliding Door Pull

426

Material: Aluminium

Finish:

● Clear Anodized

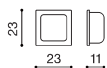

427

Material: Aluminium

Finish:

● Clear Anodized

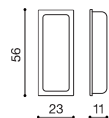

428

Material: Aluminium

Finish:

● Clear Anodized

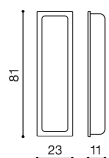

429

Material: Aluminium

Finish:

● Clear Anodized

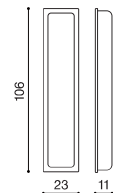

One side

Agaho

Sliding Door Lock Set

427L

Material: Aluminium

Finish:

● Clear Anodized

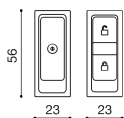

Agaho

Sliding Door Pull

416

Material: Aluminium

Finish:

● Clear Anodized

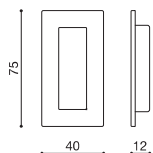

One side

AgahoS-line

Sliding Door Pull

425

Material: Aluminium

Finish:

● Clear Anodized

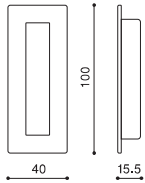

One side

Agaho

Sliding Door Pull

400

Material: Aluminium

Finish:

● Clear Anodized

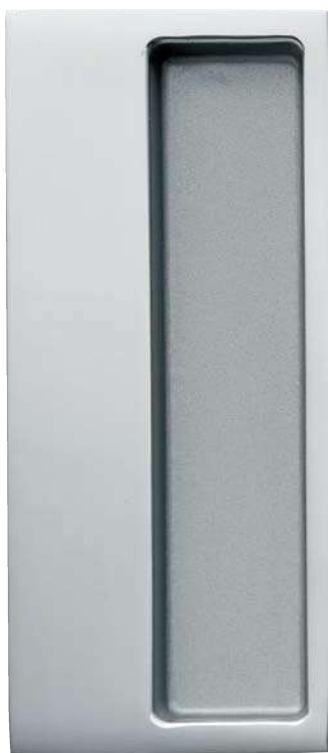
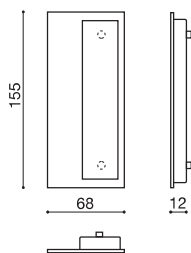

Agaho

Pocket Door Pull

10B

Material: Stainless Steel

Finish:

● Silver Hairline

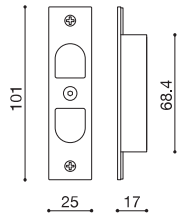

Agaho

Door Bolt

10A

Material:
Aluminium
Stainless Steel

Finish:
● Clear Anodized

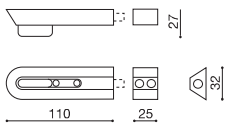

Door Chain

10K

Material:
Aluminium
Stainless Steel
Leather

Finish:
● Clear Anodized

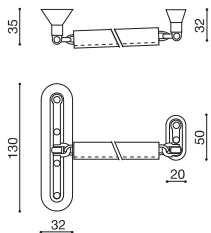

Agaho

Door Stopper

11D

Material:
Rubber / Zinc

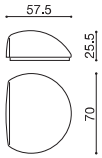

Agaho

Door Stopper

12D

Material:
Aluminium / Rubber

Finish:
● Clear Anodized

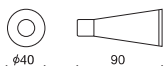

13D

Material:
Aluminium / Rubber

Finish:
● Clear Anodized



Agaho S-line

Door Stopper

20D

Material:
Aluminium / Rubber

Finish:
● Clear Anodized

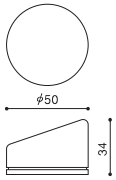

21D

Material:
Aluminium / Rubber

Finish:
● Clear Anodized

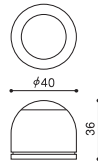

Agaho S-line

Door Stopper

23D

Material:
Aluminium / Rubber

Finish:
● Clear Anodized

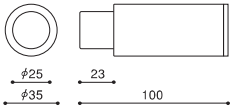

24D

Material:
Aluminium / Rubber

Finish:
● Clear Anodized

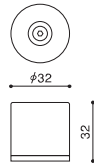

Agaho S-line

Door Stopper 25D

Material:
Aluminium / Rubber

Finish:
● Clear Anodized

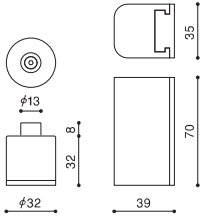

Door Stopper

26D

Material: Aluminium

Finish:

● Black

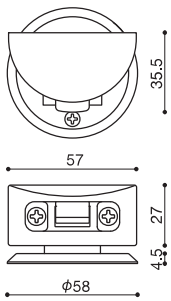





Agaho

Cabinet Knob

10P

Material: Aluminium

Finish:

● Clear Anodized



11P

Material: Aluminium

Finish:

● Clear Anodized

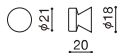

12P

Material: Aluminium

Finish:

● Clear Anodized

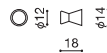

17P

Material: Aluminium

Finish:

● Clear Anodized



18P

Material: Aluminium

Finish:

● Clear Anodized



19P

Material: Aluminium

Finish:

● Clear Anodized

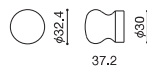

20P

Material: Aluminium

Finish:

● Clear Anodized

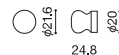

Agaho

Cabinet Pull

21P

Material: Aluminium

Finish:

● Clear Anodized

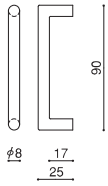

22P

Material: Aluminium

Finish:

● Clear Anodized

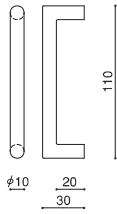

23P

Material: Aluminium

Finish:

● Clear Anodized

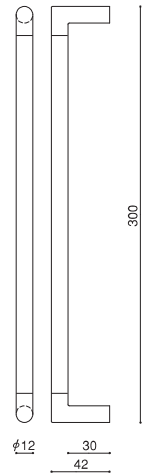

Agaho

Cabinet Flush Pull

24P

Material: Aluminium

Finish:

● Clear Anodized

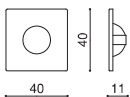

Cabinet Knob

25P

Material: Aluminium

Finish:

● Clear Anodized

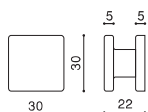



Accessory	Robe Hook	64
	Shelf	66
	Toilet Paper Holder	67
	Towel Rail / Ring	70

Robe Hook Agaho

Agaho S-line

13C P. 64



14C P. 64



17C P. 65



Shelf Agaho

12M P. 66



17M P. 66



Toilet Paper Holder Agaho

13M P. 68



14M P. 68



18M P. 69



19M P. 69



Agaho S-line

43M P. 67



Towel Rail / Ring
Agaho

10M P.70



11M P.70



20M P.71



Agaho S-line

23M P.72



24M P.72



27M P.73



28M P.73



36M P.74



37M P.75



41M P.75



Agaho

Robe Hook

13C

Material: Aluminium

Finish:

● Clear Anodized

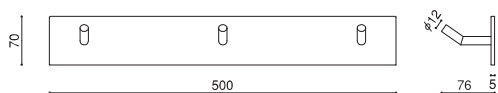

Robe Hook

14C

Material: Aluminium

Finish:

● Clear Anodized

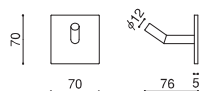

Agaho S-line
Robe Hook
17C

Material: Aluminium

Finish:

● Clear Anodized

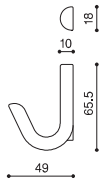

Agaho

Shelf

12M

Material: Aluminium / Glass

Finish:

● Clear Anodized

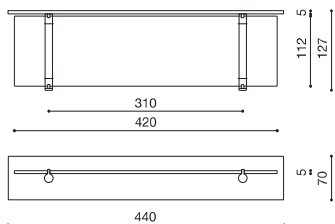

Shelf

17M

Material: Aluminium

Finish:

● Clear Anodized

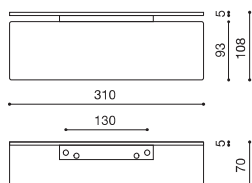

Agaho S-line

Toilet Paper Holder

43M

Material: Aluminium

Finish:

● Clear Anodized

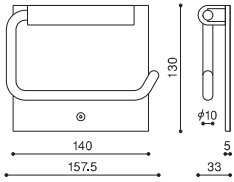

Agaho

Toilet Paper Holder

13M

Material: Aluminium

Finish:

● Clear Anodized

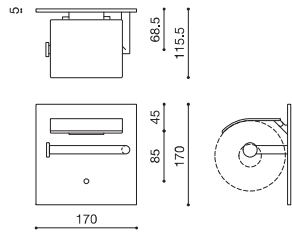

14M

Material: Aluminium

Finish:

● Clear Anodized

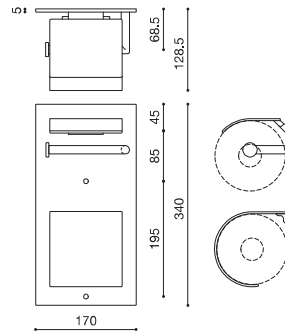

Agaho

Toilet Paper Holder

18M

Material: Aluminium

Finish:

● Clear Anodized

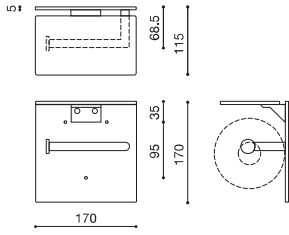

19M

Material: Aluminium

Finish:

● Clear Anodized

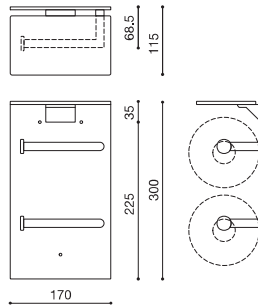

Agaho

Towel Rail

10M

Material: Aluminium

Finish:

● Clear Anodized

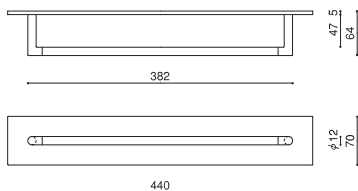

11M

Material: Aluminium

Finish:

● Clear Anodized

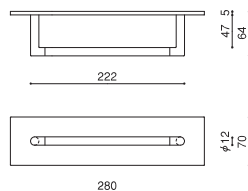

Agaho

Towel Rail

20M

Material: Aluminium

Finish:

● Clear Anodized

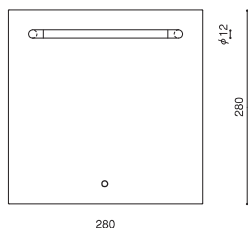
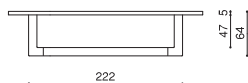

Agaho S-line

Towel Rail

23M

Material: Aluminium

Finish:

● Clear Anodized

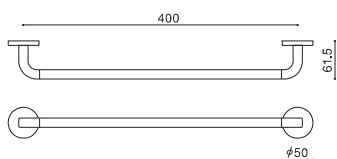

24M

Material: Aluminium

Finish:

● Clear Anodized

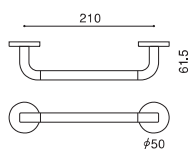

Agaho

Towel Rail

27M

Material: Aluminium

Finish:

● Clear Anodized

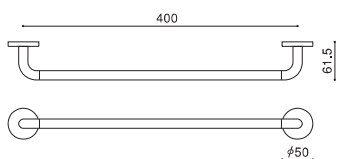

28M

Material: Aluminium

Finish:

● Clear Anodized

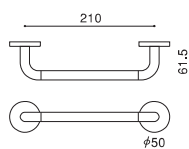

Agaho S-line

Towel Ring

36M

Material: Aluminium

Finish:

● Clear Anodized

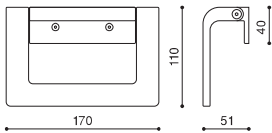

Agaho S-line

Towel Ring

41M

Material: Aluminium

Finish:

● Clear Anodized

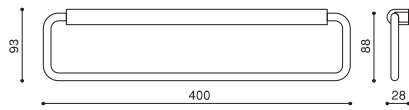

37M

Material: Aluminium

Finish:

● Clear Anodized

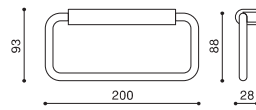

Agahobrass

Lever Handle



Robe Hook



Towel Rail



Agaho Brass	Lever Handle	79
	Escutcheon	79
	Cabinet Knob	80
	Robe Hook	81
	Toilet Paper Holder	82
	Towel Rail	83

Lever Handle
Agaho brass

220 ● ● P. 79



Escutcheon

950 ● ● P. 79



Cabinet Knob
Agaho brass

37P ● ● P. 80



38P ● ● P. 80



39P ● ● P. 80



Robe Hook
Agaho brass

15C ● ● P. 81



Toilet Paper Holder
Agaho brass

35M ● ● P. 82



Towel Rail
Agaho brass

31M ● ● P. 83



30M ● ● P. 83



Agaho brass

Lever Handle

220

Material:
Brass

Finish:

- Gold Polish
- Silver Polish

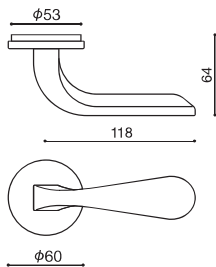

Escutcheon

950

Euro Profile Cylinder Escutcheon

Material: Brass
Finish:

- Gold Polish
- Silver Polish

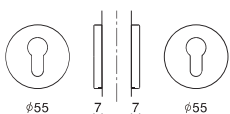

Agaho brass

Cabinet Knob

37P

Material:

Brass

Finish:

● Gold Polish

● Silver Polish

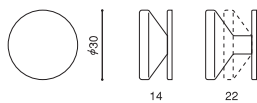

Cabinet Knob

38P

Material:

Brass

Finish:

● Gold Polish

● Silver Polish

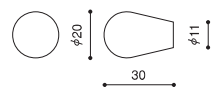

39P

Material:

Brass

Finish:

● Gold Polish

● Silver Polish

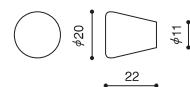

Agaho brass

Robe Hook

15C

Material: Brass

Finish:

● Gold Polish

● Silver Polish

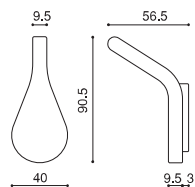

Agaho brass



Toilet Paper Holder

35M

Material:
Brass

Finish:

- Gold Polish
- Silver Polish

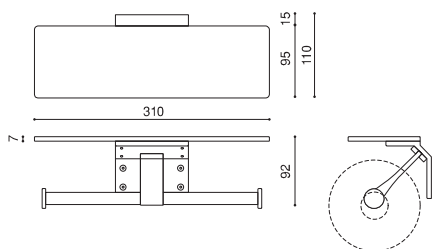

Agaho brass

Towel Rail

31M

Material:
Brass

Finish:

- Gold Polish
- Silver Polish

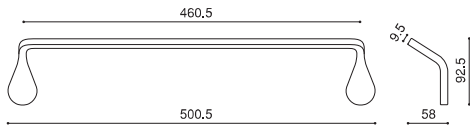

30M

Material:
Brass

Finish:

- Gold Polish
- Silver Polish

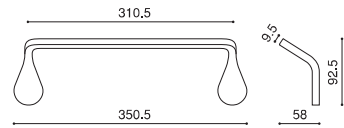



General Information	About Us	86
	Material and Finish	87
	Technical Information	88
	Order Guide	90
	Article Number List	92
	Terms and Conditions	96

About Us



Company Name

WEST inx Ltd.

Headquarters

3-18-3 Shimeno, Neyagawa-city, Osaka
572-0077 Japan

Established

Oct. 1933

President

Yasuo Nishi

ISO

ISO9001 certified in 1998

WEST has its origins in a factory named "Nishi Seisakusho"(Nishi's factory) founded in 1933 by Mr.Asajiro Nishi. He started with manufacturing of locks and ironmongery hardwares mainly for vessels at Mitejima, near Osaka sea port. About a few years later, the product range had shifted to the category of house building hardware due to the large demands of rapid economic growth.

In 1965, the factory was moved to Neyagawa City where has been a main artery between Kyoto and Osaka since ancient times. At that time, major locking system of sliding door was still screw-in type. Our development of the CL lock, which enables users to lock in a single action, was an epoch-making and brought a big boom in the hardware industry. Following that, we released the Automatic Sliding Door Closer as well as the Push-Pull Lever handle lock. As a result of these developments, WEST started to be known as a manufacturer that creates totally new, innovative and user-friendly products.

Throughout the 1970s and 80s, with highly increasing of housing demand, our product range was greatly widened in accordance with the needs of the market. To meet the market tough demand of quality, cost and lead time, we have been supplying only the best products up until today.

The end of the 1980s was at the peak of the growing Japanese economy in the era of gaudy and gorgeous things were preferred. On the other hand, however, WEST has dared to start a new project, because it was necessary to create a new product range with universality and true values in order to further enrich the spaces of daily life. We came to believe that the new product range must be useful and usable in a long term while attracting a strong attachment from its users. As a result, we have been through many continuous try and error, the first products in the Agaho series were created in 1992. The products that have followed the first Agaho items also embody fundamental ideas and most of them have received Good Design Awards (the Japanese comprehensive design evaluation and commendation) in 1992,2003 and 2008. Not only winning the awards in Japan, those products have received the Gold Prize at the iF Design award in Germany, 2008.

Our present corporate trademark was created a modified letter "W". This shape was inspired by the tip of a Bit Key and shows the WEST identity. We are proud of manufacturing locks and cylinders not only for the domestic market but also for the international market. The most important requirement for manufacturing lock is reliability. Therefore, we believe that our WEST trademark is a guarantee of trust.

In 2010, "Nishi Seisakusho" (the manufacturing headquarters of WEST group) changed its company name to WEST inx Ltd. The word "inx" indicates the meaning of two words starting with "in" -"innovative" and "inspiring"

-that express our company ideals, and "x" shows that the two words are joined in mutual effect. This name originates in the desire of our company to continue creating unique innovative products, and also to have a presence that may help architects and designers to create inspiring living spaces. Moreover, the name implies our stance of cutting through the coming era and our will to revolutionize ourselves in order to match rapid changes in society.



Tokyo Showroom



Osaka Showroom

Material and Finish

Aluminium

Material

Aluminium is the world's most used metal after steel, mainly extracted from bauxite, and its supply is comparatively stable. In particular, aluminium is highly recyclable and the energy required to produce a recycled ingot from scrap is only about 3% of that required to produce primary aluminium. Because it is comparatively lightweight, it can be said that aluminium is also environmentally friendly in transport and delivery.

Finish

The surface is anodized after it is molded and polished, and a naturally silver oxidized layer is generated. Anodized aluminium has a unique soft gloss, feeling, warmth, and gentleness, which is very precious. Moreover, users do not need to be concerned with fingerprints on the surface, with the advantage of minimizing daily cleaning.

Special color coated products is also available on request.



Brass

Material

Brass is an alloy of copper and zinc that has an appearance similar to gold. It is a material familiar from ancient times as an interior product with elegant characteristics.

Finish

There are color choices of gold and silver to enhance any space.



Gold Polish (GB)

This is coated with clear lacquer, which maintains the attractiveness of polished brass. Because it also prevents the patina peculiar to brass, daily maintenance is easier.



Silver Polish (SC)

This is a chrome-plate finish that fits simple space, making the most of the dignified feeling of brass.

Technical Information

Lever Handle and Door Knob

Advanced Spindle Structure

A stainless steel plate is inserted into a slot of a square spindle. After setting the lever or knob to the spindle and fixing the grub screw, the plate is pushed in (figs. 1 and 2). At the same moment, the plate slides up from the edge of the spindle (fig. 3) and presses the lock-follower from inside. Extra movement between the spindle and the lock-follower can be avoided in this way, and the structure brings the smooth operation of levers and knobs.

The spindle is 8 mm square and comes with operable pairs of levers and knobs for the standard door thickness as stated below.

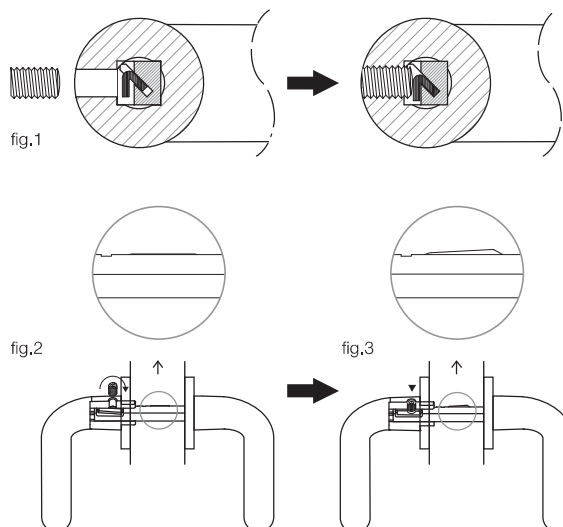

Available Range of the Door Thickness

Agaho Lever Handle: 33 - 60 mm (146, 148, 149 and 185)

Agaho Door Knob: 33 - 60 mm (154, 192, 193 and 194)

Agaho S-line Lever Handle: 35 - 50 mm (209 - 238)

Please contact us beforehand in cases where the door thickness does not match the above dimensions. Also in cases where the lock case is not in the center of the door (fig.A), inform us of the distance off-center.

When ordering, specifying the door thickness is always required even if the thickness is in the above available range.

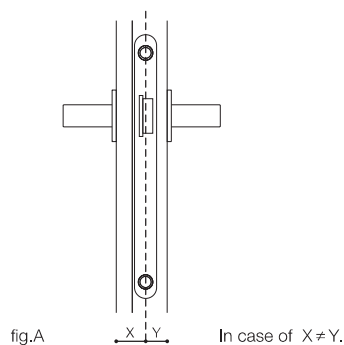

Rose and Escutcheon



Bolt-through concealed fixing with two screws at 38 mm distance (fig. B). Round Rose and Square Rose are interchangeable in Agaho S-line lever handles 209 to 238. Non-standard combination is available on request. Cylinder escutcheons for Euro Profile (PZ) and keyhole escutcheons for Standard Profile are available in both round and square shape.

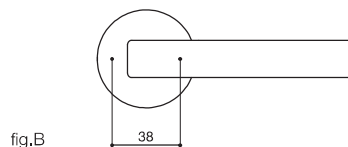

Bathroom Set



In case of emergency, it can be unlocked with a coin from the outside. When using 952 and 952S, occupancy can be ascertained by the red indicator.

The bathroom set has an 8 mm square spindle and can be used with a lock case that have minimum \varnothing 6.5 mm through holes at 38 mm distance.

Window Handle

For Tilt & Turn windows

The handles stop in 4 positions at 90-degree intervals. Optionally, handles for night ventilation opening set that stop at 45-degree intervals are also available.

Dimensions related to installation are as follows.

Fixing Centre: 43 mm

Support Lug: \varnothing 10 mm

5 mm in length

Spindle Size: 7 mm square

Spindle Projection Length: 42 mm (standard)

* Please contact us when the spindle in different length will be required.

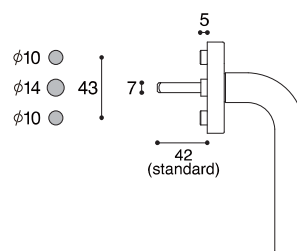

Notes

- Hard materials such as rings might damage the surface of our products. This does not impair the functioning. It simply shows the passage of time.
- Please follow the fitting instructions provided with our products in order to carry out proper installation. Please contact us when additional information is needed.
- Technical details or information may change without notice. Please contact us when you need updates.
- Improper usage, incorrect handling, or faulty installation may cause injury or damage the product.

Examples of improper usage / prohibited acts

- * Stepping or hanging on the product.
- * Using a handle or towel rail as a hook.
Do not hang anything heavier than specified in the fitting instructions.
- * Slamming the door open so that the handle strikes a wall.
- * Using a product as a children's plaything.

If there are any questions, please contact us.

Order Guide

How to read the article numbers

Lever Handle and Door Knob

The article numbers for lever handles and door knobs consist of the combination of Model Number and Sub Code. Especially for 217, please also confirm which is required Left-hand or Right-hand lever.

EX: 217 Lever Handle (R) + 950 Escutcheon



217-BR

Model Number

Sub Code

- A: Lever Handle
- B: Lever Handle + 950 Escutcheon**
- C: Lever Handle + 957 Escutcheon
- D: Lever Handle + 951 Bathroom Set
- E: Lever Handle + 952 Bathroom Set

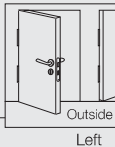

Outside
Left

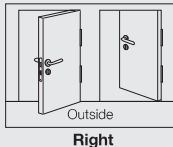

Outside
Right

EX: 194 Door Knob (Single-side / Fixed)



194-HF

Model Number

Sub Code

- A: Door Knob (Pair / Operable)
- AF: Door Knob (Pair / Fixed)
- HF: Door Knob (Single-side / Fixed)**

Window Handle

To identify the shape of the handle rose, the article numbers have Sub Code after their Model Number.

EX: 214W Window Handle (Square Rose)



214W-S

Model Number

Sub Code

- O: Oval Rose
- S: Square Rose**

Pull Handle

For 9401 and 9402, there is Sub Code which indicates the handle length and whether the handle is a pair or single-side.

EX: 9402 Pull Handle (Single-side / 600 mm)

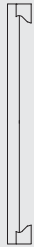

9402-600H

Model Number

Sub Code

- 300: Pull Handle (Pair / 300 mm)
- 300H: Pull Handle (Single-side / 300 mm)
- 600: Pull Handle (Pair / 600 mm)
- **600H: Pull Handle (Single-side / 600 mm)**
- 1000: Pull Handle (Pair / 1,000 mm)
- 1000H: Pull Handle (Single-side / 1,000 mm)

Other point

Some of the article numbers have Color Code after their Model Number.

EX: 30M Towel Rail (Silver Polish)

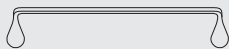

30M-SC

Model Number

Color Code

- GB: Gold Polish
- **SC: Silver Polish**

Things to note when ordering

- * Please specify the thickness of the door every time when ordering lever handles, door knobs, pull handles, pad handles, and sliding door lock sets (427L, 431L, 432L and 435L).
- * In cases where the lock case is not in the center of the door, note the position off-center.
- * Please arrange required anchors in cases where the provided screws cannot be used.
- * Unless otherwise agreed in writing, by submitting a sales order we assume that Buyer is agreeing to be bound by our Terms and Conditions.

Article Number List

Lever Handle

Model No.	Article No.	Brand	Description	Page
146	146-A	Agaho	146 Lever Handle	6
	146-B	Agaho	146 Lever Handle + 950 Escutcheon	
	146-C	Agaho	146 Lever Handle + 957 Escutcheon	
	146-D	Agaho	146 Lever Handle + 951 Bathroom Set	
	146-E	Agaho	146 Lever Handle + 952 Bathroom Set	
148	148-A	Agaho	148 Lever Handle	7
	148-B	Agaho	148 Lever Handle + 950 Escutcheon	
	148-C	Agaho	148 Lever Handle + 957 Escutcheon	
	148-D	Agaho	148 Lever Handle + 951 Bathroom Set	
	148-E	Agaho	148 Lever Handle + 952 Bathroom Set	
149	149-A	Agaho	149 Lever Handle	8
	149-B	Agaho	149 Lever Handle + 950 Escutcheon	
	149-C	Agaho	149 Lever Handle + 957 Escutcheon	
	149-D	Agaho	149 Lever Handle + 951 Bathroom Set	
	149-E	Agaho	149 Lever Handle + 952 Bathroom Set	
185	185-A	Agaho	185 Lever Handle	9
	185-B	Agaho	185 Lever Handle + 950 Escutcheon	
	185-C	Agaho	185 Lever Handle + 957 Escutcheon	
	185-D	Agaho	185 Lever Handle + 951 Bathroom Set	
	185-E	Agaho	185 Lever Handle + 952 Bathroom Set	
209	209-A	Agaho S-line	209 Lever Handle	10
	209-B	Agaho S-line	209 Lever Handle + 950 Escutcheon	
	209-C	Agaho S-line	209 Lever Handle + 957 Escutcheon	
	209-D	Agaho S-line	209 Lever Handle + 951 Bathroom Set	
	209-E	Agaho S-line	209 Lever Handle + 952 Bathroom Set	
210	210-A	Agaho S-line	210 Lever Handle	11
	210-B	Agaho S-line	210 Lever Handle + 950 Escutcheon	
	210-C	Agaho S-line	210 Lever Handle + 957 Escutcheon	
	210-D	Agaho S-line	210 Lever Handle + 951 Bathroom Set	
	210-E	Agaho S-line	210 Lever Handle + 952 Bathroom Set	
211	211-A	Agaho S-line	211 Lever Handle	12
	211-B	Agaho S-line	211 Lever Handle + 950 Escutcheon	
	211-C	Agaho S-line	211 Lever Handle + 957 Escutcheon	
	211-D	Agaho S-line	211 Lever Handle + 951 Bathroom Set	
	211-E	Agaho S-line	211 Lever Handle + 952 Bathroom Set	
212	212-A	Agaho S-line	212 Lever Handle	13
	212-B	Agaho S-line	212 Lever Handle + 950 Escutcheon	
	212-C	Agaho S-line	212 Lever Handle + 957 Escutcheon	
	212-D	Agaho S-line	212 Lever Handle + 951 Bathroom Set	
	212-E	Agaho S-line	212 Lever Handle + 952 Bathroom Set	
214	214-A	Agaho S-line	214 Lever Handle	14
	214-B	Agaho S-line	214 Lever Handle + 950 Escutcheon	
	214-C	Agaho S-line	214 Lever Handle + 957 Escutcheon	
	214-D	Agaho S-line	214 Lever Handle + 951 Bathroom Set	
	214-E	Agaho S-line	214 Lever Handle + 952 Bathroom Set	
215	215-A	Agaho S-line	215 Lever Handle	15
	215-B	Agaho S-line	215 Lever Handle + 950 Escutcheon	
	215-C	Agaho S-line	215 Lever Handle + 957 Escutcheon	
	215-D	Agaho S-line	215 Lever Handle + 951 Bathroom Set	
	215-E	Agaho S-line	215 Lever Handle + 952 Bathroom Set	
217	217-AR	Agaho S-line	217 Lever Handle [R]	16
	217-BR	Agaho S-line	217 Lever Handle [R] + 950 Escutcheon	
	217-CR	Agaho S-line	217 Lever Handle [R] + 957 Escutcheon	
	217-DR	Agaho S-line	217 Lever Handle [R] + 951 Bathroom Set	
	217-ER	Agaho S-line	217 Lever Handle [R] + 952 Bathroom Set	
	217-AL	Agaho S-line	217 Lever Handle [L]	
	217-BL	Agaho S-line	217 Lever Handle [L] + 950 Escutcheon	
	217-CL	Agaho S-line	217 Lever Handle [L] + 957 Escutcheon	
	217-DL	Agaho S-line	217 Lever Handle [L] + 951 Bathroom Set	
	217-EL	Agaho S-line	217 Lever Handle [L] + 952 Bathroom Set	
219	219-A	Agaho S-line	219 Lever Handle	17
	219-B	Agaho S-line	219 Lever Handle + 950 Escutcheon	
	219-C	Agaho S-line	219 Lever Handle + 957 Escutcheon	
	219-D	Agaho S-line	219 Lever Handle + 951 Bathroom Set	
	219-E	Agaho S-line	219 Lever Handle + 952 Bathroom Set	
238	238-A	Agaho S-line	238 Lever Handle	18
	238-B	Agaho S-line	238 Lever Handle + 950 Escutcheon	
	238-C	Agaho S-line	238 Lever Handle + 957 Escutcheon	
	238-D	Agaho S-line	238 Lever Handle + 951 Bathroom Set	
	238-E	Agaho S-line	238 Lever Handle + 952 Bathroom Set	
220	220-A-GB	Agaho brass	220 Lever Handle (Gold Polish)	79
	220-A-SC	Agaho brass	220 Lever Handle (Silver Polish)	
	220-B-GB	Agaho brass	220 Lever Handle + 950 Escutcheon (Gold Polish)	
	220-B-SC	Agaho brass	220 Lever Handle + 950 Escutcheon (Silver Polish)	

Article Number List

Door Knob

Model No.	Article No.	Brand	Description	Remarks	Page
154	154-A	Agaho	154 Door Knob (Pair / Operable)		20
	154-AF	Agaho	154 Door Knob (Pair / Fixed)	Standard specification: For Glass Door 8-15 mm thick,	
	154-HF	Agaho	154 Door Knob (Single-side / Fixed)		
192	192-A	Agaho	192 Door Knob (Pair / Operable)		22
	192-AF	Agaho	192 Door Knob (Pair / Fixed)	Standard specification: For Glass Door 8-15 mm thick,	
	192-HF	Agaho	192 Door Knob (Single-side Fixed)		
193	193-A	Agaho	193 Door Knob (Pair / Operable)		23
	193-AF	Agaho	193 Door Knob (Pair / Fixed)	Standard specification: For Glass Door 8-15 mm thick,	
	193-HF	Agaho	193 Door Knob (Single-side Fixed)		
194	194-A	Agaho	194 Door Knob (Pair / Operable)		21
	194-AF	Agaho	194 Door Knob (Pair / Fixed)	Standard specification: For Glass Door 8-15 mm thick,	
	194-HF	Agaho	194 Door Knob (Single-side Fixed)		

Escutcheon

Article No.	Brand	Description	Remarks	Page
950	Agaho/Agaho S-line	950 Euro Profile Cylinder Escutcheon		24
951	Agaho/Agaho S-line	951 Bathroom Set		
952	Agaho/Agaho S-line	952 Bathroom Set with Indicator		
957	Agaho/Agaho S-line	957 Standard Profile Escutcheon		
950S	Agaho/Agaho S-line	950S Euro Profile Cylinder Escutcheon (Square)		25
951S	Agaho/Agaho S-line	951S Bathroom Set (Square)		
952S	Agaho/Agaho S-line	952S Bathroom Set with Indicator (Square)		
957S	Agaho/Agaho S-line	957S Standard Profile Escutcheon (Square)		
950-GB	Agaho brass	950 Euro Profile Cylinder Escutcheon (Gold Polish)		79
950-SC	Agaho brass	950 Euro Profile Cylinder Escutcheon (Silver Polish)		

Window Handle

Model No.	Article No.	Brand	Description	Remarks	Page
209W	209W-O	Agaho/Agaho S-line	209W Window Handle (Oval Rose)		26,27
	209W-S	Agaho/Agaho S-line	209W Window Handle (Square Rose)		
211W	211W-O	Agaho/Agaho S-line	211W Window Handle (Oval Rose)		
	211W-S	Agaho/Agaho S-line	211W Window Handle (Square Rose)		
214W	214W-O	Agaho/Agaho S-line	214W Window Handle (Oval Rose)	Please prepare M5 countersunk head screw,	
	214W-S	Agaho/Agaho S-line	214W Window Handle (Square Rose)		
219W	219W-O	Agaho/Agaho S-line	219W Window Handle (Oval Rose)		
	219W-S	Agaho/Agaho S-line	219W Window Handle (Square Rose)		
238W	238W-O	Agaho/Agaho S-line	238W Window Handle (Oval Rose)		
	238W-S	Agaho/Agaho S-line	238W Window Handle (Square Rose)		

Pull Handle

Model No.	Article No.	Brand	Description	Remarks	Page
9401	9401-300	Agaho	9401 Pull Handle (Pair / 300 mm)		32
	9401-300H	Agaho	9401 Pull Handle (Single-side / 300 mm)		
	9401-600	Agaho	9401 Pull Handle (Pair / 600 mm)		
	9401-600H	Agaho	9401 Pull Handle (Single-side / 600 mm)		
9402	9402-300	Agaho	9402 Pull Handle (Pair / 300 mm)		33
	9402-300H	Agaho	9402 Pull Handle (Single-side / 300 mm)		
	9402-600	Agaho	9402 Pull Handle (Pair / 600 mm)		
	9402-600H	Agaho	9402 Pull Handle (Single-side / 600 mm)		
	9402-1000	Agaho	9402 Pull Handle (Pair / 1,000 mm)		
	9402-1000H	Agaho	9402 Pull Handle (Single-side / 1,000 mm)		
9002	9002	Agaho	9002 Pull Handle	Standard Configuration: Pair	33
9003	9003	Agaho	9003 Pull Handle	Standard Configuration: Pair	
9004	9004	Agaho	9004 Pull Handle	Standard Configuration: Pair	

Pad Handle

Article No.	Brand	Description	Remarks	Page
9030	Agaho	9030 Pad Handle		35
9040	Agaho	9040 Pad Handle	Standard Configuration: Pair	34
9050	Agaho	9050 Pad Handle		35

Article Number List

Sliding Door Pull

Article No.	Brand	Description	Remarks	Page
416	Agaho	416 Sliding Door Pull		42
425	Agaho S-line	425 Sliding Door Pull		43
426	Agaho	426 Sliding Door Pull		40
427	Agaho	427 Sliding Door Pull		
427L	Agaho	427 Sliding Door Lock Set	Including Lock, Strike Plate and Box.	41
428	Agaho	428 Sliding Door Pull		40
429	Agaho	429 Sliding Door Pull		
431	Agaho	431 Sliding Door Pull		38
431L	Agaho	431 Sliding Door Lock Set	Including Lock, Strike Plate and Box.	
432	Agaho	432 Sliding Door Pull		39
432L	Agaho	432 Sliding Door Lock Set	Including Lock, Strike Plate and Box.	
435	Agaho	435 Sliding Door Pull	Standard Configuration: Pair	36
435L	Agaho	435 Sliding Door Lock Set	Including Lock, Strike Plate and Box.	37
400	Agaho	400 Sliding Door Pull		44
10B	Agaho	10B Pocket Door Pull		45

Door Stopper

Article No.	Brand	Description	Remarks	Page
11D	Agaho	11D Door Stopper		47
12D	Agaho	12D Door Stopper		48
13D	Agaho	13D Door Stopper		
20D	Agaho S-line	20D Door Stopper		49
21D	Agaho S-line	21D Door Stopper		
23D	Agaho S-line	23D Door Stopper		50
24D	Agaho S-line	24D Door Stopper		
25D	Agaho S-line	25D Door Stopper		51
26D	Agaho S-line	26D Door Stopper		52

Door Chain / Bolt

Article No.	Brand	Description	Remarks	Page
10A	Agaho	10A Door Bolt		46
10K	Agaho	10K Door Chain	There are restrictions on the fixing point.	

Cabinet Knob / Pull

Article No.	Brand	Description	Enclosed screw and the thickness of Cabinet Doors	Page
10P	Agaho	10P Cabinet Knob	M4 x 20 and 30 mm	56
11P	Agaho	11P Cabinet Knob	M4 x 20 and 30 mm	
12P	Agaho	12P Cabinet Knob	M4 x 20 and 30 mm	
17P	Agaho	17P Cabinet Knob	M4 x 20 and 30 mm	
18P	Agaho	18P Cabinet Knob	M4 x 20 and 30 mm	
19P	Agaho	19P Cabinet Knob	M4 x 20 and 30 mm	
20P	Agaho	20P Cabinet Knob	M4 x 20 and 30 mm	
21P	Agaho	21P Cabinet Pull	M4 x 35 mm	57
22P	Agaho	22P Cabinet Pull	M4 x 35 mm	
23P	Agaho	23P Cabinet Pull	M4 x 35 mm	58
24P	Agaho	24P Cabinet Flush Pull	M3 x 18 mm	
25P	Agaho	25P Cabinet Knob	M4 x 20 and 30 mm	
37P-GB	Agaho brass	37P Cabinet Knob (Gold Polish)	[Fixing nut]	80
37P-SC	Agaho brass	37P Cabinet Knob (Silver Polish)	[Fixing nut]	
38P-GB	Agaho brass	38P Cabinet Knob (Gold Polish)	M4 x 20 and 30 mm	
38P-SC	Agaho brass	38P Cabinet Knob (Silver Polish)	M4 x 20 and 30 mm	
39P-GB	Agaho brass	39P Cabinet Knob (Gold Polish)	M4 x 20 and 30 mm	
39P-SC	Agaho brass	39P Cabinet Knob (Silver Polish)	M4 x 20 and 30 mm	

Article Number List

Robe Hook

Article No.	Brand	Description	Remarks	Page
13C	Agaho	13C Robe Hook		64
14C	Agaho	14C Robe Hook		
15C-GB	Agaho brass	15C Robe Hook (Gold Polish)		81
15C-SC	Agaho brass	15C Robe Hook (Silver Polish)		
17C	Agaho S-line	17C Robe Hook		65

Shelf

Article No.	Brand	Description	Remarks	Page
12M	Agaho	12M Shelf		66
17M	Agaho	17M Shelf		

Toilet Paper Holder

Article No.	Brand	Description	Remarks	Page
13M	Agaho	13M Toilet Paper Holder		68
14M	Agaho	14M Toilet Paper Holder		
18M	Agaho	18M Toilet Paper Holder		69
19M	Agaho	19M Toilet Paper Holder		
35M-GB	Agaho brass	35M Toilet Paper Holder (Gold Polish)		82
35M-SC	Agaho brass	35M Toilet Paper Holder (Silver Polish)		
43M	Agaho S-line	43M Toilet Paper Holder		67

Towel Rail / Ring

Article No.	Brand	Description	Remarks	Page
10M	Agaho	10M Towel Rail		70
11M	Agaho	11M Towel Rail		
20M	Agaho	20M Towel Rail		71
23M	Agaho S-line	23M Towel Rail		72
24M	Agaho S-line	24M Towel Rail		
27M	Agaho S-line	27M Towel Rail		73
28M	Agaho S-line	28M Towel Rail		
30M-GB	Agaho brass	30M Towel Rail (Gold Polish)		83
30M-SC	Agaho brass	30M Towel Rail (Silver Polish)		
31M-GB	Agaho brass	31M Towel Rail (Gold Polish)		
31M-SC	Agaho brass	31M Towel Rail (Silver Polish)		
36M	Agaho S-line	36M Towel Ring		74
37M	Agaho S-line	37M Towel Ring		75
41M	Agaho S-line	41M Towel Ring		

Terms and Conditions

1. GENERAL

- a. Buyer must read these terms and conditions carefully before ordering any of our products, and by submitting a sales order, Buyer shall agree to be bound by these terms and conditions. Unless otherwise agreed in writing, all orders and quotations apply to these terms and conditions.
- b. These terms and conditions are always valid in their most recent form. Seller notifies Buyer in advance when updating this agreement.
- c. Communication between Buyer and Seller shall be in English or Japanese.
- d. Notices sent from Seller to Buyer shall be deemed to reach when on the rules below.
[Facsimile, e-mail]
At the time Seller has made the notice.
[Prepaid Postage, Registered Airmail]
10 days after posting.

2. QUOTATION, ORDER

- a. Quotation issued by a request of Buyer does not mean the acceptance of the order.
- b. Order must be given in writing. Verbal agreements are not effective.
- c. Order shall be effective when Buyer receives a written confirmation from Seller.
- d. Seller makes an effort to send order confirmation to Buyer within the next business day of the order reached. And also Seller may refuse the order. If the order confirmation will not reach to Buyer within 3 business days, confirm to Seller.
- e. Specification of product such as spindle size, door thickness shall be specified on the order.
- f. If Buyer will request an arrangement of delivery to Seller, delivery information (address, transport, insurance, etc.) shall be specified on the order or the request for quotation.
- g. Modification of the order shall be confirmed in writing by prior agreement.
- h. Order can be revoked if the written revocation reaches to Seller before Seller has dispatched a confirmation.
Revocation after conclusion of order is not acceptable.

3. PRODUCTS, PRICE

- a. Price of quotation and on the price list shall be valid on order within the expiration date on each of them.
- b. Considering the cost of crude oil, raw material and exchange rate etc., Seller has the right to change price freely by prior notice to Buyer.
- c. Price is not included necessary cost such as taxes, freight, packing cost, insurance fee and etc.
- d. Parts used for products may be improved without a prior notice.
- e. Buyer shall judge the product whether it is suitable to the purpose of use or not. Seller is not liable to the intended use of Buyer.

4. DELIVERY

- a. Delivery date notified to Buyer is foreseeable endeavor date of Seller.
- b. Buyer cannot refuse partial delivery.
- c. Delivery date may be revised in case of modification of order.
- d. Seller can arrange delivery as Buyer's alternative. Buyer shall specify the delivery information (address, transport, insurance, etc.) on application of quotation or on order.
- e. Unless otherwise agreed in writing, Buyer shall take over risks of delivery at the time when Seller passes products to forwarder or transporter.

- f. Seller shall not be liable at the event of late delivery after shipment, which is caused by custom clearance, traffic conditions, weather conditions, and the lack of delivery information from Buyer.
- g. Seller shall not be liable at the event of late delivery which is caused by Force Majeure such as natural disasters, war, legal restrictions or any other causes beyond the control of Seller.
- h. Unless otherwise agreed in writing, Buyer shall absorb freight, packing fee, insurance and other expenses.

5. PAYMENT, RETURN POLICY

- a. Unless otherwise agreed in writing, payment shall be due to the date on each order confirmation.
- b. Payment shall be by telegram transfer (T/T) remittance or guarantee by letter of credit (L/C) by the currency designated on the order confirmation. Check and Bill of exchange are not acceptable.
- c. Buyer shall absorb commission charges due to the payment.
- d. In case Buyer fails to pay the price for products in time, Buyer shall pay interest at the rate of 3% above bank rate of Bank of Japan.
- e. In case Buyer fails to pay the price for products in time, Seller shall be entitled to suspend the shipment or make them delay.
- f. Return products are not acceptable in principle.

6. INSPECTION

- a. Buyer shall inspect products immediately after receiving products whether there are no defects such as damages, shortage and wrong shipping. If any of defects are detected, Buyer shall claim in writing within 5 business days after receiving products and shall send photos of defect and shipping information to Seller. Seller makes effort to reply to Buyer against the claim within 5 business days after receiving the claim from Buyer.
- b. No claim in above period deemed as free from claim regarding 6-a.
- c. Concealed defects must be notified in writing to Seller without delay upon detection.

7. RETENTION OF TITLE

- a. Seller shall keep the title of retention of products until full amount of the payment will complete.
- b. Buyer shall be entitled to re-sell the products even if the payment is not completed.
- c. Seller shall be entitled to keep the title of retention of defective product even if the payment is completed.
- d. In case of credit insecurity (bankruptcy, proceedings of corporate reorganization) of Buyer will be disclosed, Seller shall be entitled to revoke the proceeding order or to withhold the reserved products which had already delivered to Buyer.
- e. Buyer shall keep Seller's reserved products separate from their stock, and mark them as Seller's property.

8. WARRANTY

- a. Seller guarantees the technical operation in normal use of products for a period of 2 years from the date of delivery.
In the event of claiming defects, Buyer shall submit the proof of purchase with date and other means such as photos required by Seller.

- b. Seller shall judge the suspected product by photos etc., whether it has defect or not. In addition, Seller shall be entitled to withdraw the defective product by requesting to Buyer.
- c. In case the product is assessed as defect, Seller shall undertake any of way issuing credit note, off-set statement, replace products or replace parts.
- d. Defects caused by improper handling and fixing is not acceptable. Also mere defects that reduce slight value or functionality of product are not acceptable.

9. TRADEMARK and COPYRIGHT

- a. Buyer must not refer to the name of Seller and Seller's trademarks as products in connection with any advertising without Seller's prior permission.
- b. Copyright in any catalog, brochure or other literature supplied with products shall not be infringed by Buyer.

10. GOVERNING LAW and DISPUTE RESOLUTION

- a. This agreement shall be governed by and construed in accordance with the laws of Japan including United Nations Convention on Contracts for the International Sales of Goods (CISG - "Vienna Sales Convention").
- b. All disputes or controversies shall be finally settled by arbitration to be held in Osaka, Japan administered by the Japan Commercial Arbitration Association.

- Unless otherwise indicated, product sizes written in this catalog are all in millimeters(mm).
- Technical information might change without a prior notice.
- The actual color of the product may differ slightly from the catalog due to the printing issue.
- WEST inx Ltd. and its affiliates. All rights reserved.
Any other use, reproduction, republication of the content of this catalog is prohibited.

WEST inx Ltd.

Headquarters

3-18-3 Shimeno, Neyagawa-city, Osaka
572-0077 Japan

Export Sales Division

4-3-22 Imabashi, Chuo-ku, Osaka
541-0042 Japan

TEL +81-6-6221-5887
FAX +81-6-6221-5888

info@west-inx.com
www.west-inx.com



WEST