

Flush Pull

311

詳細図

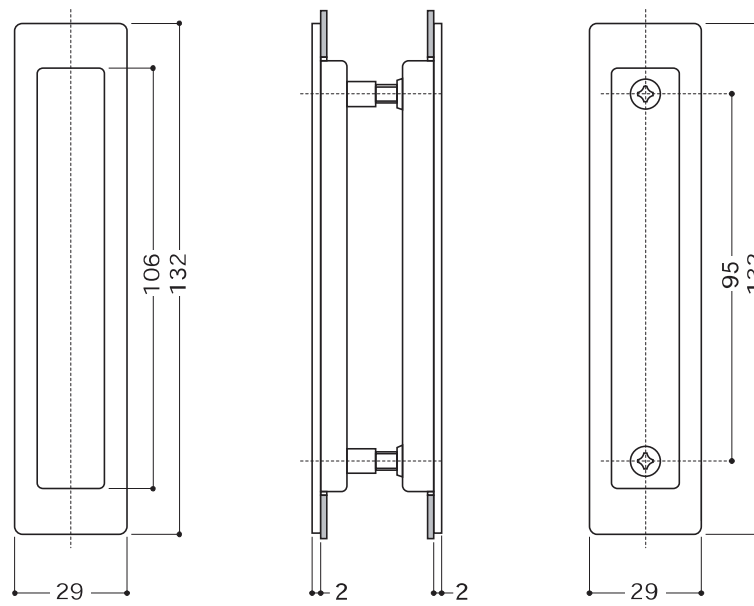

切欠図

