

431/432/435 間仕切用錠ケース

4×20 皿 タッピングネジ1種

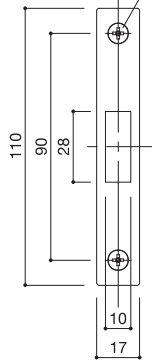

ストライク

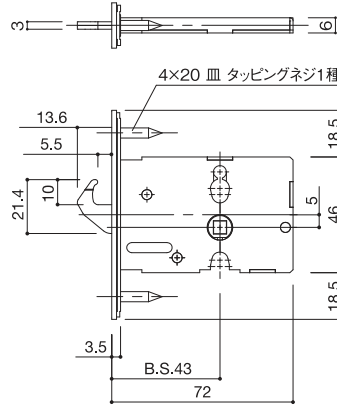
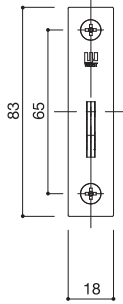

切欠図

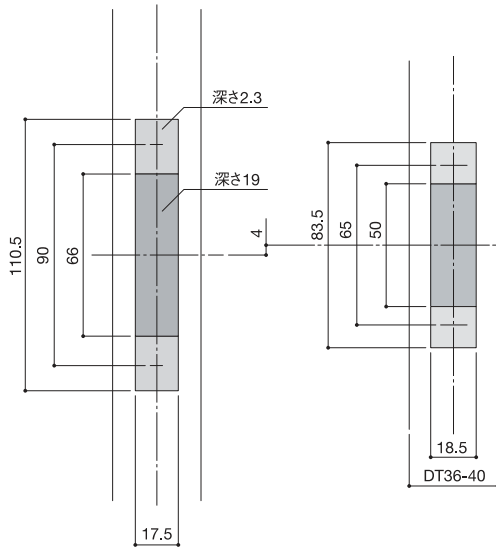

431間仕切錠用切欠図

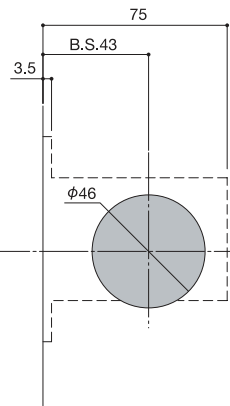

432間仕切錠用切欠図

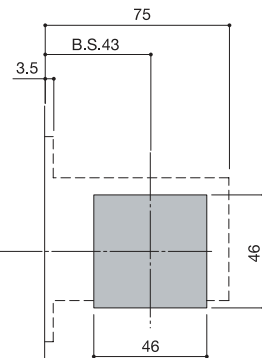

431プレーンタイプ切欠図

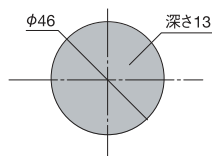

432プレーンタイプ切欠図

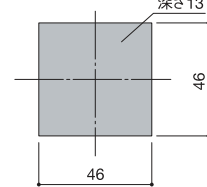

435間仕切錠用切欠図

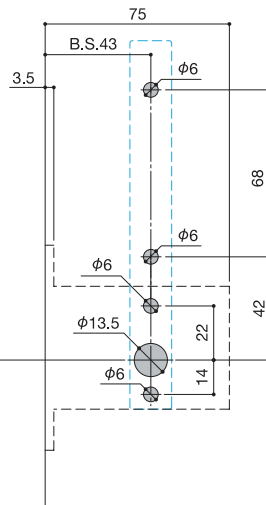
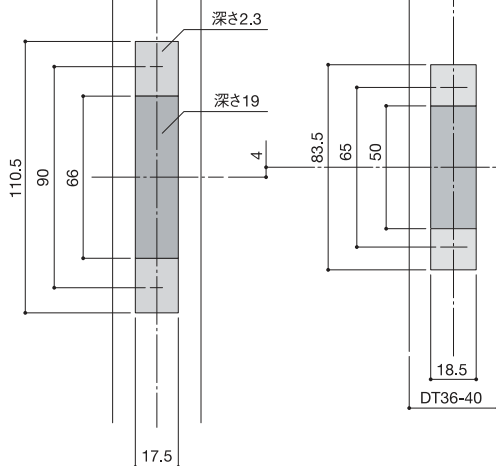

435プレーンタイプ切欠図

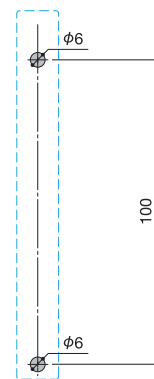

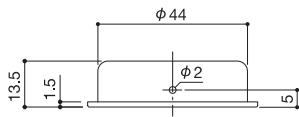

**431**  
プレーンタイプ

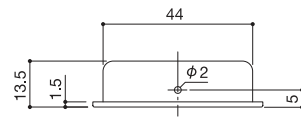

**432**  
プレーンタイプ

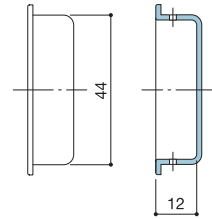
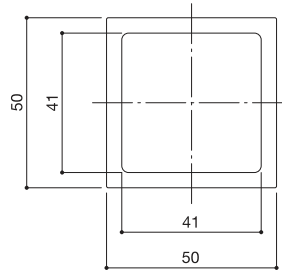
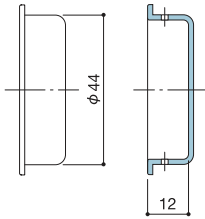
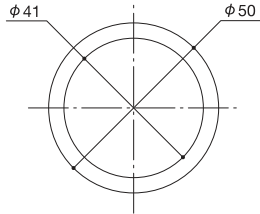

**431**  
間仕切錠タイプ

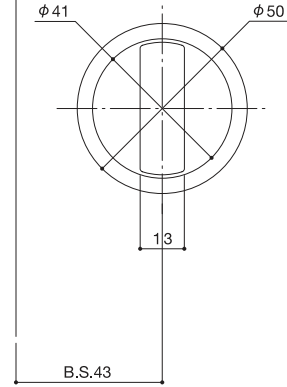
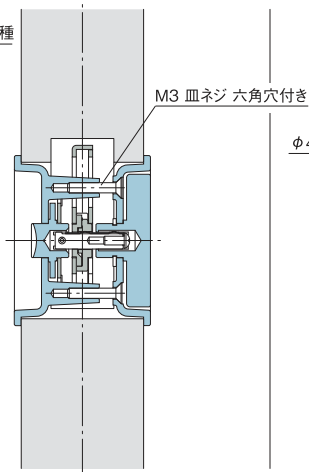
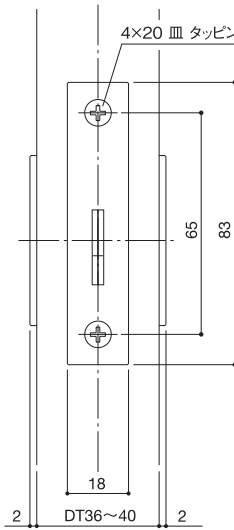
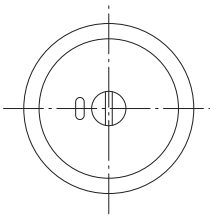

**432**  
間仕切錠タイプ

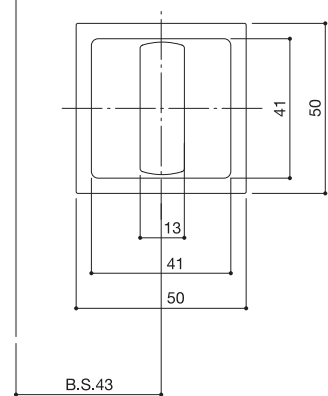
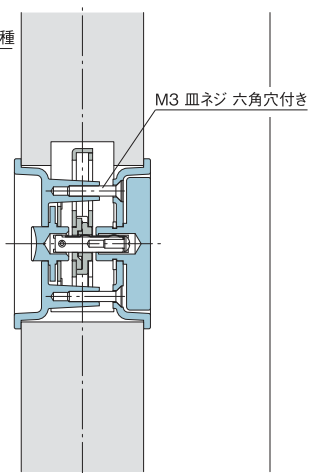
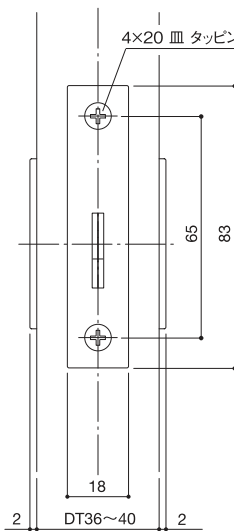
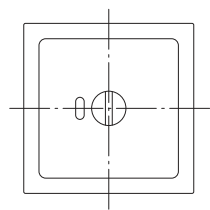

**435**  
プレーンタイプ

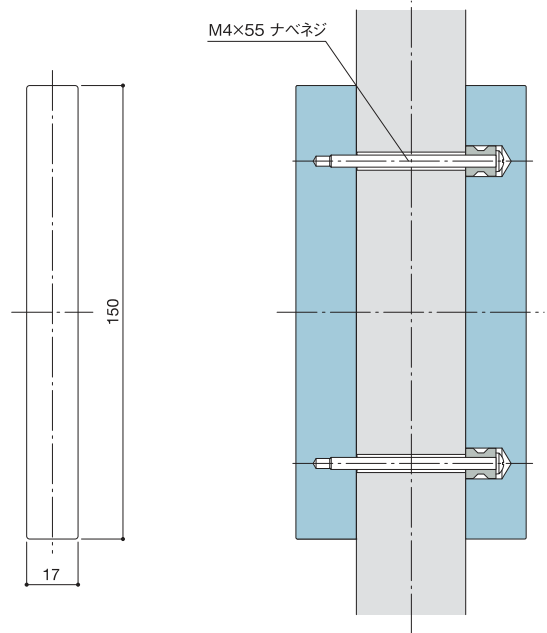
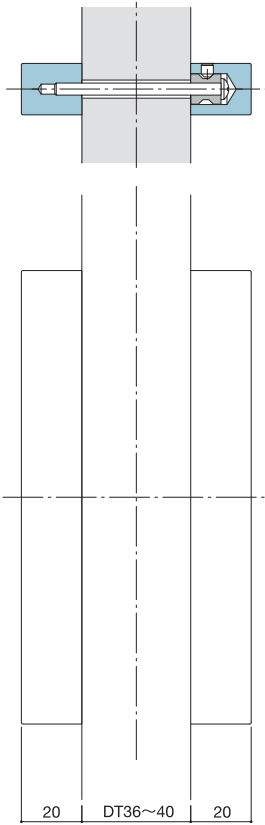

**435**  
間仕切錠タイプ

