

Flush Pull

322

詳細図

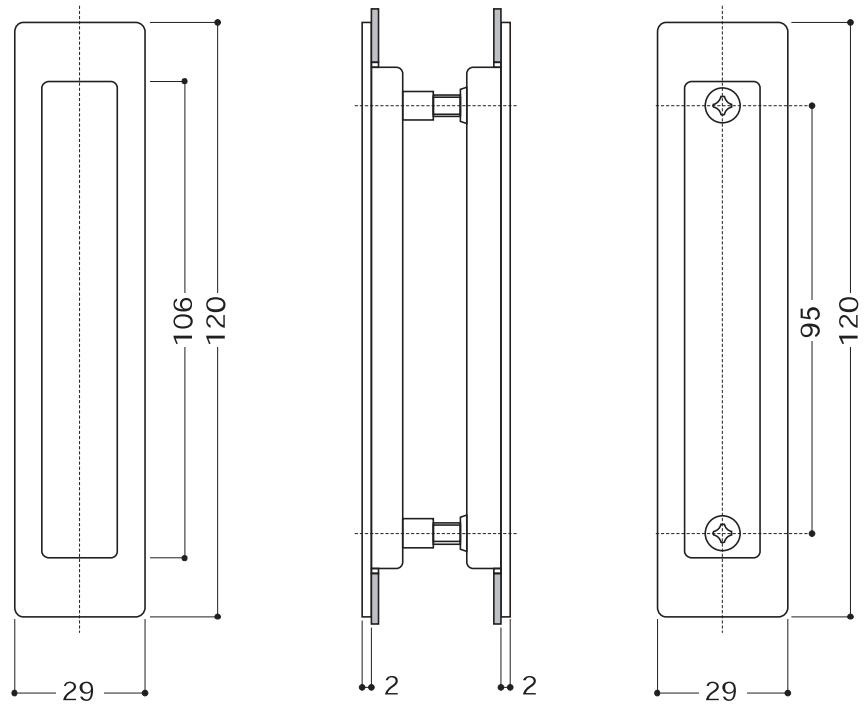

切欠図

