

Toilet Paper Holder

Agaho 14M



Fitting Instruction

components

- A : Paper Holder 1pc
- B : Allen Screw 4pcs
- C : Allen Key 1pc

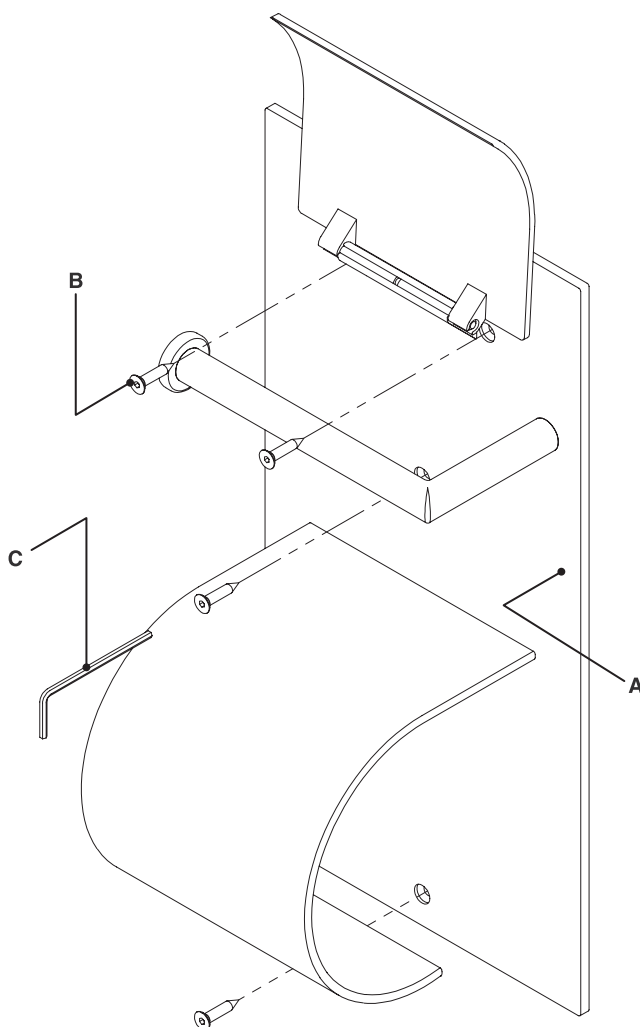

*Drill pilot holes $\Phi 2 - 2.5\text{mm}$

⚠ Attention

Load capacity: Up to 3kg

Do not use the product as a step and never hang on to it. These improper use causes the injury.

Make sure to install the product to the place where all the screws hold tightly.

If the provided screws are not suitable to the wall, please arrange anchor bolts etc.

Notes

- 1 Please read this instruction well and be sure to install the product correctly. After installation, user shall keep this instruction.
- 2 Please pay attention, not to drop and not to damage the product by fixing tools and etc. while installing.
- 3 Check the installation position before drilling the fixing face.
- 4 Do not use impact drill because it may become hard to remove.
- 5 Do not remodel the product. Do not use the parts except we specify.
- 6 Do not use for a purpose other than the intended use of the product.
- 7 After installation, please confirm whether the product was correctly installed and tightly fixed.
- 8 Avoid installing the product where directly wet with water.

Maintenance

- 1 Check the product regularly and tighten the screw again if it was loose.
- 2 Wipe with soft and dry cloth to clean products.
To remove tough stains use water with soft cloth or sponge, and then wipe enough to dry up.

Regular Cleaning	To remove tough stain	DO NOT USE
Wipe with soft & dry cloth. 	Use water to remove tough stain. Then, dry surface with soft cloth. 	



WEST inx Ltd.

3-18-3 Shimeno, Neyagawa-city, Osaka 572-0077 JAPAN

E-mail : info@west-inx.com

Website: www.west-inx.com

EU-TP02100401